

The Bandex Wave Tape Technology for Variety and Easy Handling

- Perfectly shaped, functional, individual.
- It has never been easier to create curtains with a beautiful wave look.



bandex

Our **Tapes** for the Perfect Wave

The variety of curtain fabrics requires different solutions for the curtain tapes. It doesn't matter if you have a light, medium-weight or heavy fabrics, BANDEX has the right curtain tape for all kinds of application.

Tape	Art.-No.:	Colour	Width in mm	Fullness Ratio	Depth of Pleat in cm	Glider Distance in cm	Suitable Fabrics
GEMINI variable	1044275	translucent	76	variable	variable	6/8	medium heavy
GEMINI variable*	1044351	translucent	76	variable	variable	6/8	medium heavy
GEMINI variable	1044279	black	76	variable	variable	6/8	medium heavy
GEMINI 12	1044280	translucent	76	1:1,5 / 1:2,0	10 (5/5)	8/6	medium heavy
GEMINI 1410	1044281	translucent	76	1:1,5 / 1:2,0	10 (6/4)	8/6	medium heavy
GEMINI 16	1044282	translucent	76	1:2,0	14 (7/7)	8	medium heavy
GEMINI 1810	1044283	translucent	76	1:1,75	12 (8/4)	8	medium heavy
DORADO variable	1044286	translucent	76	variable	variable	6/8	light
VESUVIO variable	1044179	white	80	variable	variable	6/8	heavy
VESUVIO 12	1044180	white	80	1:1,5 / 1:2,0	10 (5/5)	8/6	heavy
VESUVIO 1410	1044055	white	80	1:1,5 / 1:2,0	10 (6/4)	8/6	heavy

* iron on



Perfect waves for your curtain.

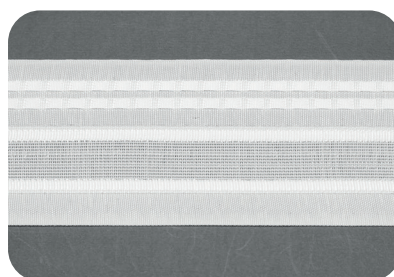

Curtain tape VESUVIO variable white.:
- Pocket repeat 1 cm

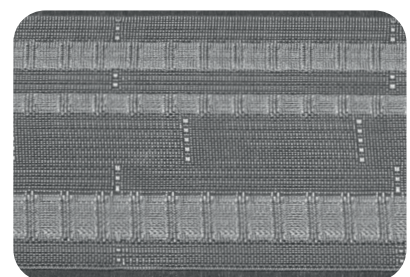

Curtain tape GEMINI variable translucent:
- Pocket repeat 1 cm
- 2. pocket row suitable for motorized track systems

Our **Technology** for the Perfect Wave

Of course, we also offer a complete range of glider tapes, cords, hooks and endpieces. Our glider tapes are unique. The tape remains with high security in the rail. The annoying falling out, as we know it from the glider cords, is therefore eliminated. The glider tapes are available with a fixed eyelet and now also with a rotating eyelet. The glider tapes and cords are delivered on a spool of 25m.

Item	Art.-No.:	Colour	Glider Distance in mm	Eyelet Rotatable	Inner Track in mm
Glider Cord	1050285	white	60	no	4
Glider Cord	1050286	white	80	no	4
Glider Cord	1050287	black	80	no	4
Glider Cord	1050222	white	60	no	6
Glider Cord	1050224	white	80	no	6
Glider Cord	1050263	black	80	no	6
Glider Cord	1050288	white	60	yes	6
Glider Cord	1050290	white	80	yes	6
Glider Cord	1050291	black	80	yes	6
Glider Tape	1050230	white	60	no	6
Glider Tape	1050231	white	80	no	6
Glider Tape	1050292	black	80	no	6
Glider Tape	1050277	white	60	yes	6
Glider Tape	1050276	white	80	yes	6
Glider Tape	1050278	black	80	yes	6

Glider Tape slim
- Rotatable



Glider Cord slim

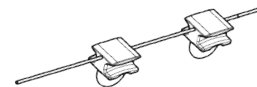

Endpiece



Single Curtain Hook



Glider Tape
- 6mm inner track
- Eyelet rotatable

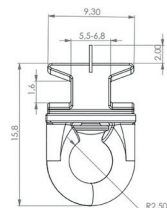

Item	Art.-No.:	Colour
Single Curtain Hook	1020072	white
Single Curtain Hook	1050264	black
Endpiece	1050279	white
Endpiece	1050280	black

Glider Cord
- 4mm inner track
- Fixed Eyelet

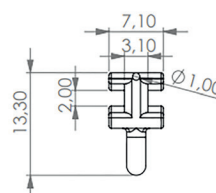

Glider Tape
- 6mm inner track
- Fixed eyelet

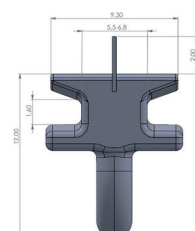

Our **Instructions** for the Perfect Wave Pleats

Variant A with Glider Distance of 6 cm:

KEEP IT SIMPLE!

Fullness Ratio	Depth of Pleat in cm	Frontside/ Backside in cm	Repeat in mm	Glider all in cm*	1st Glider in cm
1:1,5 (see Fig. 1)	7	3,5/3,5	90	9	5**
1:2,0	10	5/5	120	12	6
1:2,0	10	6/4	240	14/10	5
1:2,5 (see Fig. 2)	13	6,5/6,5	150	15	8**
1:2,5	13	8/5	300	18/12	6
1:3,0 (see Fig. 3)	16	8/8	180	18	9
1:3,0	16	10/6	360	22/14	7

* Pocket repeat 1 cm

** The return will be 0,5cm longer than the other pleats.

Examples of technical illustrations:

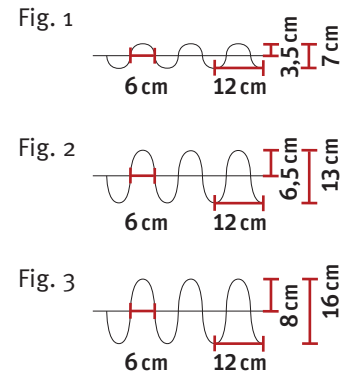

Variant B with Glider Distance of 8 cm:

Fullness Ratio	Depth of Pleat in cm	Frontside/ Backside in cm	Repeat in mm	Glider all in cm*	1st Glider in cm
1:1,5 (see Fig. 1)	10	6/4	240	14/10	5
1:1,5 (see Fig. 2)	10	5/5	120	12	6
1:1,75	12	8/4	280	18/10	5
1:1,75	12	7/5	280	16/12	6
1:1,75 (see Fig. 3)	12	6/6	140	14	7
1:2,0 (see Fig. 4)	14	9/5	320	20/12	6
1:2,0	14	8/6	320	18/14	7
1:2,0 (see Fig. 5)	14	7/7	160	16	8
1:2,25	16	10/6	360	22/14	7
1:2,25	16	9/7	360	20/16	8
1:2,25	16	8/8	180	18	9
1:2,5	18	9/9	200	20	10
1:2,75	20	10/10	220	22	11
1:3,0 (see Fig. 6)	22	11/11	240	24	12

* Pocket repeat 1 cm

Examples of technical illustrations:

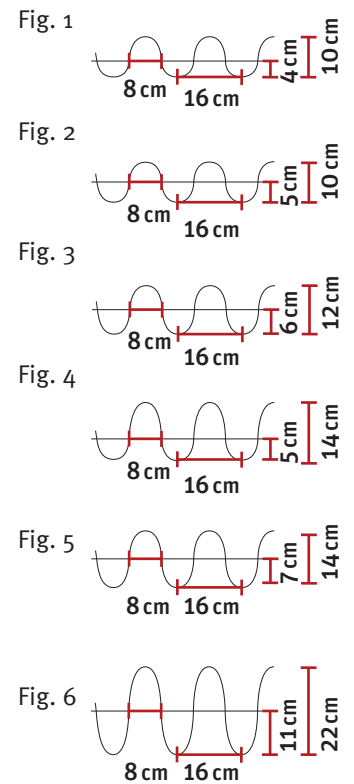

Customize Pleat Size and Volume

The latest generation of our wave tape gives you the following advantages:

- **You save time and money having simple and understandable instructions and handling.**
- **21 simple options:**
The variable tape can be processed with 6 cm and 8 cm glider spacing. We offer solutions for 7 different fullness ratios (from 1:1.5 – 1:3.0). The variants with different pleat depths at the front and back side with the same fabric consumption are also unique. This gives you a lot of flexibility as you can adjust the depth of the pleat to your requirements.
- **4 easy options with fixed fullness ratio:**
Our variants with fixed fullness ratio are also unique. Here is just a pocket where it is also needed. Ideal for the object arena. Perfect design and easy handling are not a contradiction in terms for us.
- **Available in the colors translucent, black and white:**
For particularly heavy fabrics we recommend the VESUSIO tape. This is characterized by particularly strong pockets.

For light und softly falling fabrics we recommend to use the tape DORADO.

Equal Pleat Size:

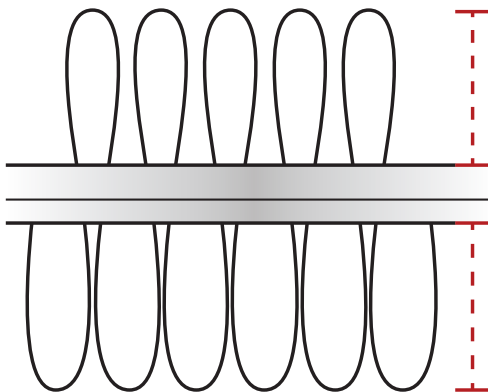

Symmetric depth of the pleat

Unequal Pleat Size:

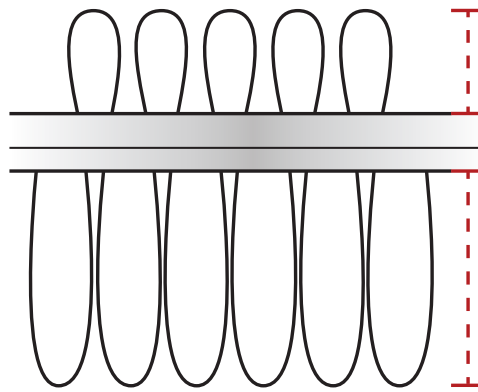

Unsymmetric depth of the pleat

Our **Options** for Variation

GEMINI and DORADO variable can be used flexibly thanks to the continuous rows of pockets. The markings in these tapes give you a fabric ratio of either 1:2.0, 1:2.5 or 1:3.0. A fabric ratio of 1:1.5 or 1:1.75 can also be customised.

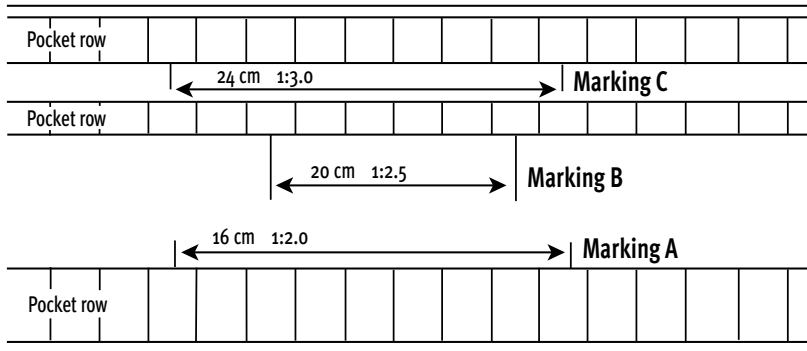

Hanging the sliders using the example of a slider cord with 8 cm spacing

For allowance 1:2.0 = every 16 cm (marking A) - wave depth: 14 cm / 7 cm at the front; 7 cm at the back

For allowance 1:2.5 = every 20 cm (marking B) - wave depth: 18 cm / 9 cm at the front; 9 cm at the back

For allowance 1:3.0 = every 24 cm (marking C) - wave depth: 22 cm / 11 cm at the front; 11 cm at the back

Sewing Guide **GEMINI**

HINT MARKING:
Big Marker - Big Wave
Small Marker - Small Wave

Our tape GEMINI doesn't only appear with perfect waves in every window, it's also an ideal solution for a room divider with hidden curtain tape.

We use 2 different fabric colours for better understanding.

- **Grey for the main curtain**
- **Purple to cover the tape when creating a room divider**

- 1.) Measure the tape and cut it (+approx. 5 cm addition right and left)
- 2.) Pick a suitable thread
- 3.) Revert the edge and sew the seams (the first pocket should be placed after the first 3-5 cm and should also end the same way)

- 4.) Start and end with the bigger wave to create complete waves from beginning till end. Note especially the first marker in the tape!

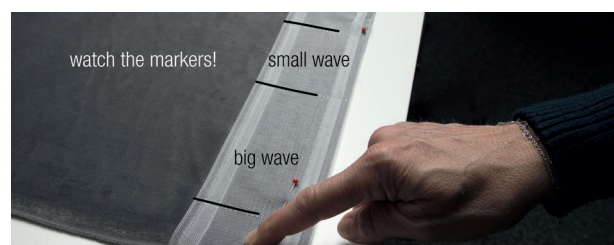

Sewing Guide **GEMINI** hidden

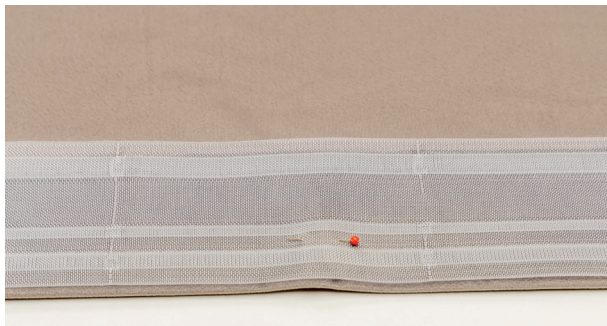
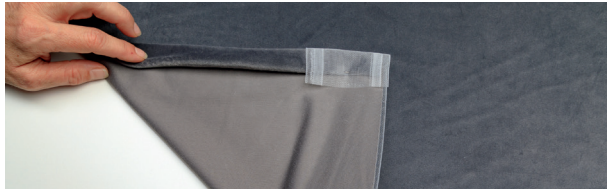

- 1.) Start as described before
- 2.) Apply a second piece of fabric. The size of the fabric should be the double width of the tape (+1-2 cm reserve)

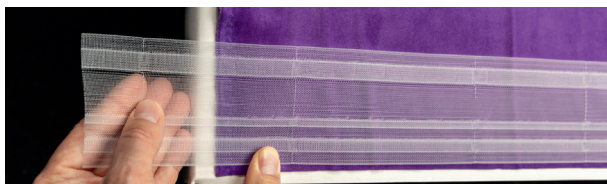

- 3.) Place the curtain tape and fix it with pins (+approx. 5 cm addition right and left)

- 4.) Sew the tape
- 5.) Place the gliders into the pockets (Attention: important!)



- 6.) Tuck in with seam



- 7.) Stitch right and left next to the gliders (leave 5 cm open)
- 8.) Use a glider cord that is suitable for your track

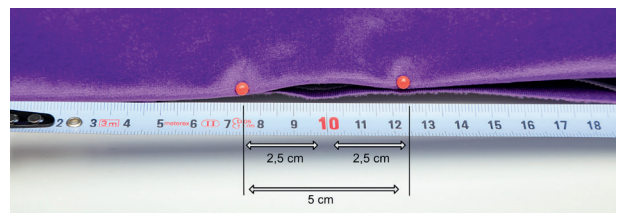

Our Helpful **Tools** for Your Support

On our web-side www.bandex.com or our App you find a lot of helpful tools, hints as well as tips and tricks as:

- **Calculator for the fabric amount**
- **Processing instructions**
- **360° views on curtains**
- **Virtual showroom**
- **Calculator for required space**

If you need a solution other than the perfect wave, our tape configurator will help you find the right tape quickly and easily.

Of course, you can also order directly via our online shop. Surf our web-side – it's worth doing it.

BANDEX is a company specialized in curtain tapes and narrow weaving with long-standing experience located in the very heart of Europe. For more than 60 years BANDEX is one of the leading specialist in the production of high-quality curtain heading tapes. Founded, grown and based in the „three-country corner“, in Koblach Austria, the company was originally specialized in zipper tapes. Today we offer around 500 standard articles as well as individual solutions on customer request in more than 55 countries worldwide.

Bandex is a medium-sized company with fully integrated production at the location in Koblach, which allows us to guarantee fast response times. Many products are gone stock available immediately. Understanding of the requirements of our customers and a fast, solution-oriented attitude characterize us.

